

Assembly Instruction

LINETU01 TV Unit

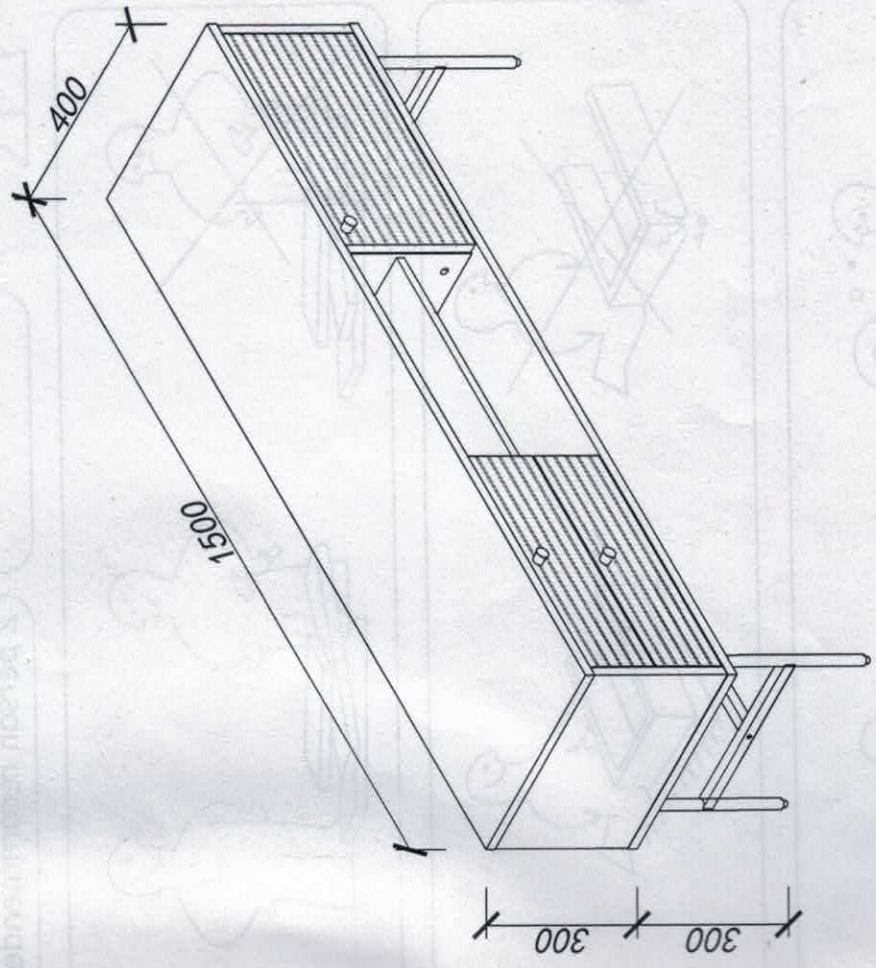

Panel No	Panel Sizes	Quantity
9	481*350*16	1
10	487*264*18	1
11	487*311*18	2
12	423*300*12	2
13	350*300*12	2
14	350*300*12	2
15	435*318*5	2

Panel No	Panel Sizes	Quantity
1	1500*400*16	1
2	1500*400*16	1
3	268*399*16	1
4	268*399*16	1
5	268*360*16	1
6	268*360*16	1
7	278*1476*5	1
8	472*350*16	1

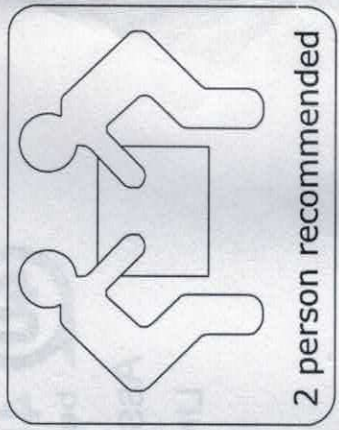
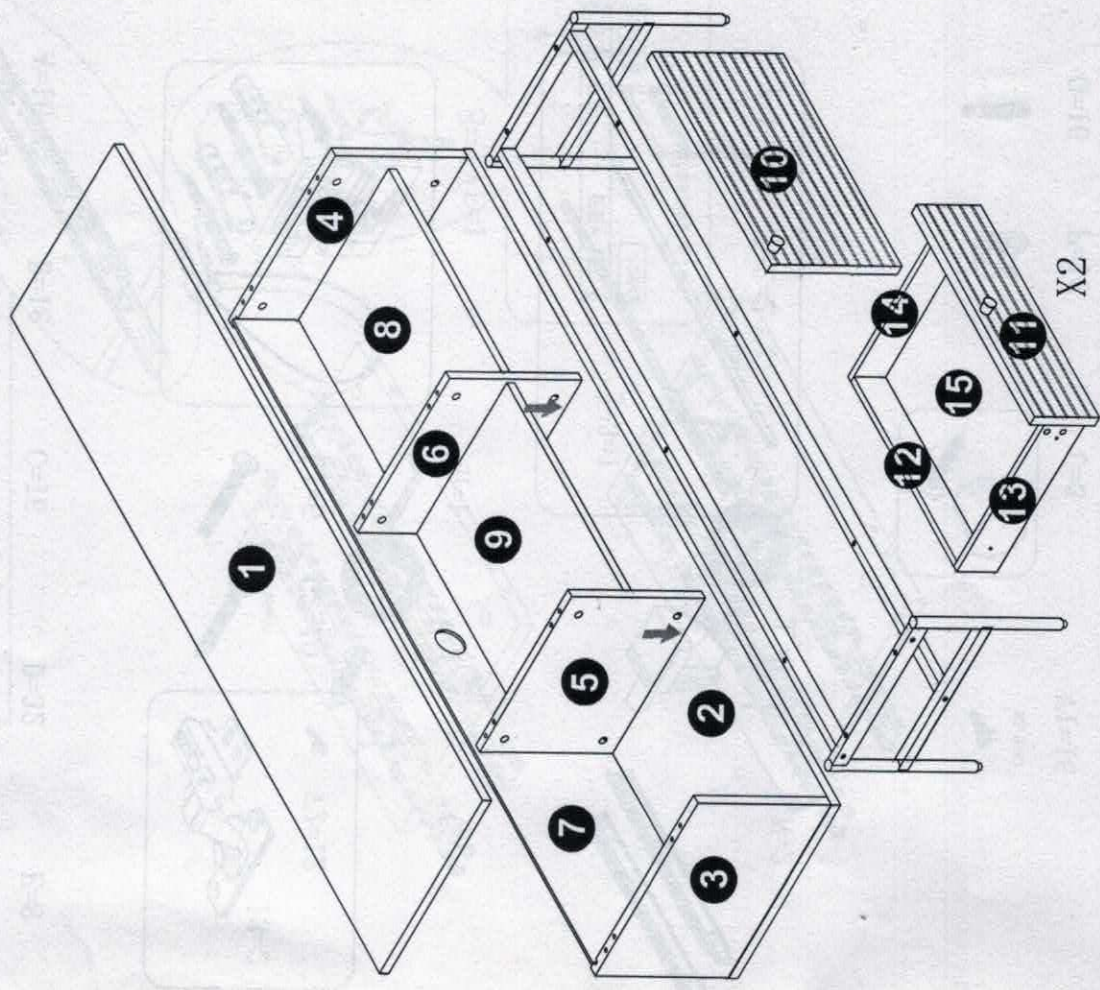

2 person recommended

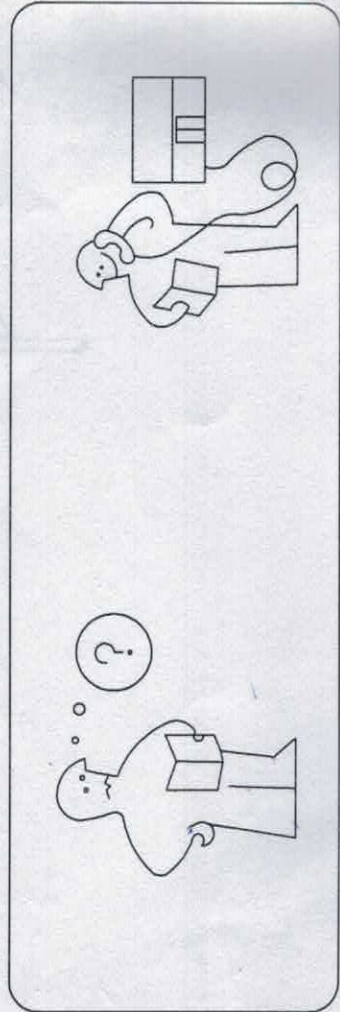
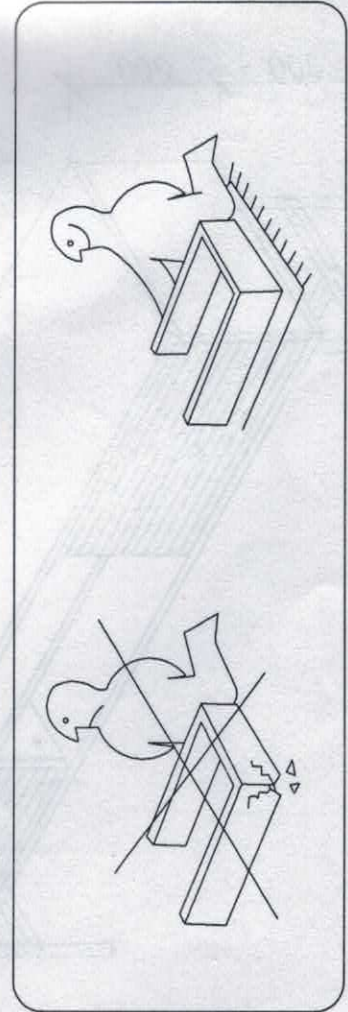
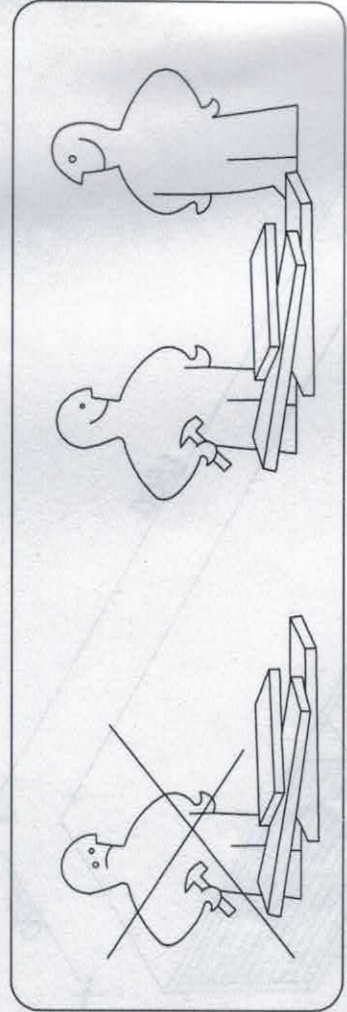
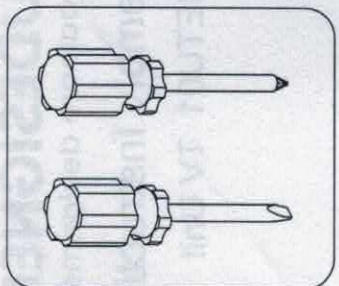

Fittings



A=16



B=16

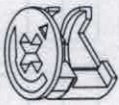

C=16



D=32



E=8

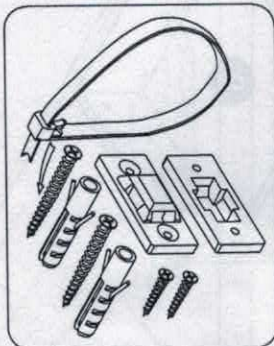

F=1



M6*30
G1=6



M6*40
G2=10



H=1



I3=2



V2=12

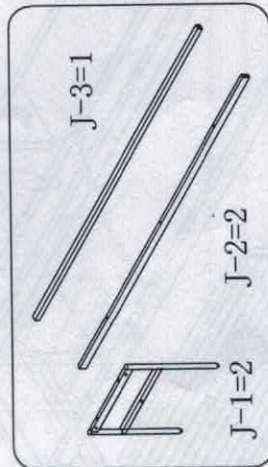

J-3=1

J-2=2

J-1=2

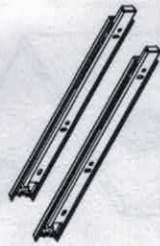

N=2

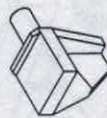

L=8



U=3



P=16



O=16



M3.5*12

V1=16

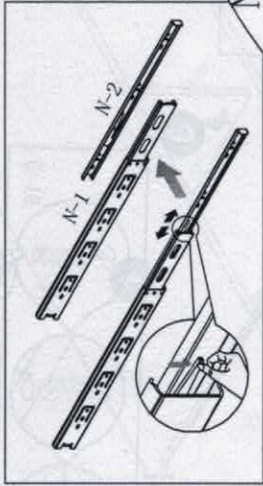

N-1=4

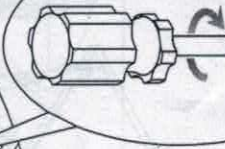
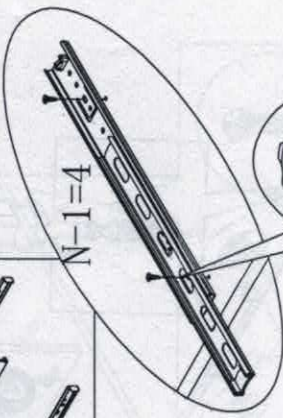

V1=8

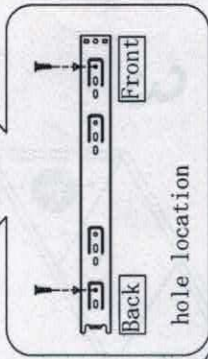

Front
Back
hole location

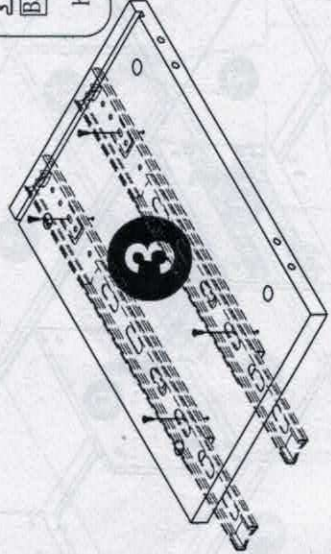
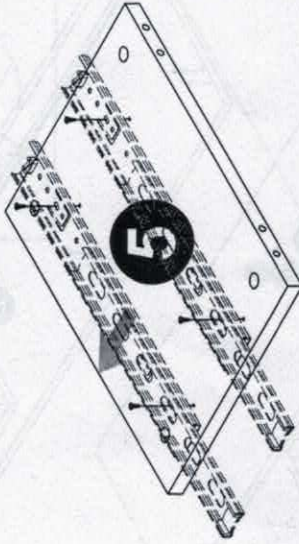

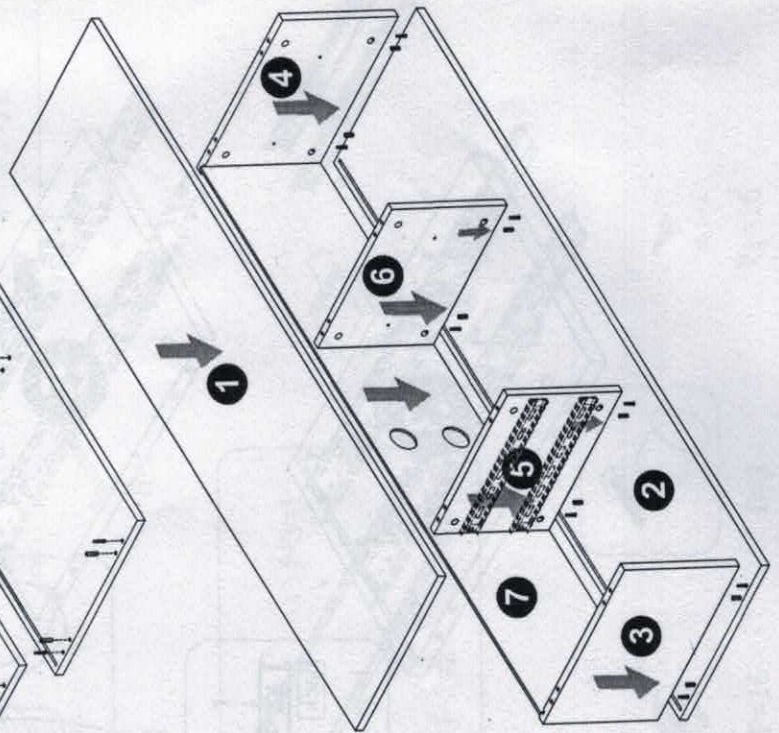
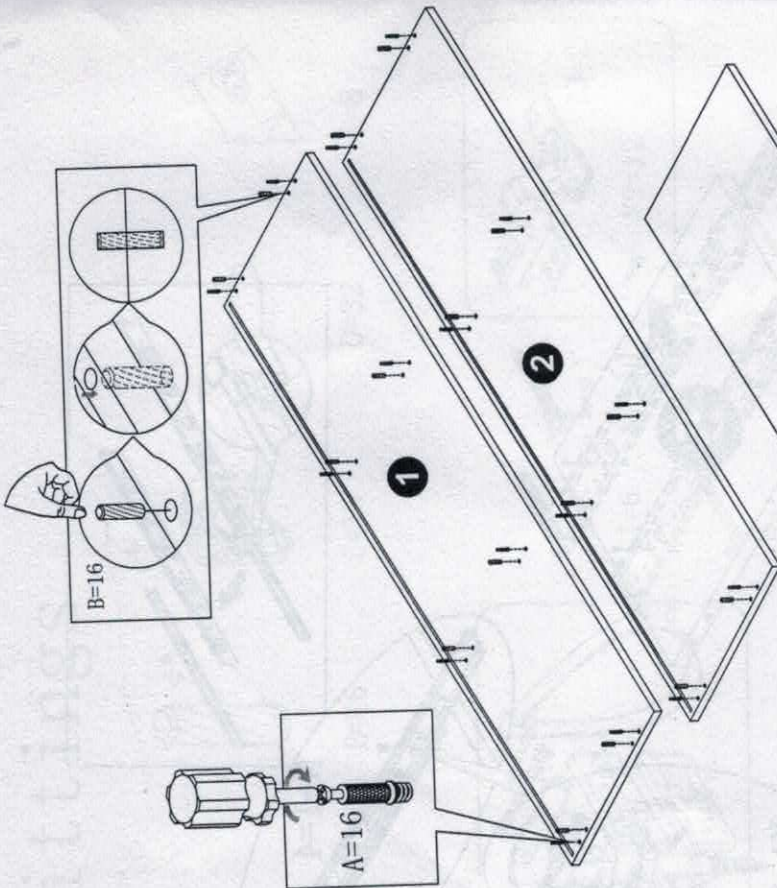
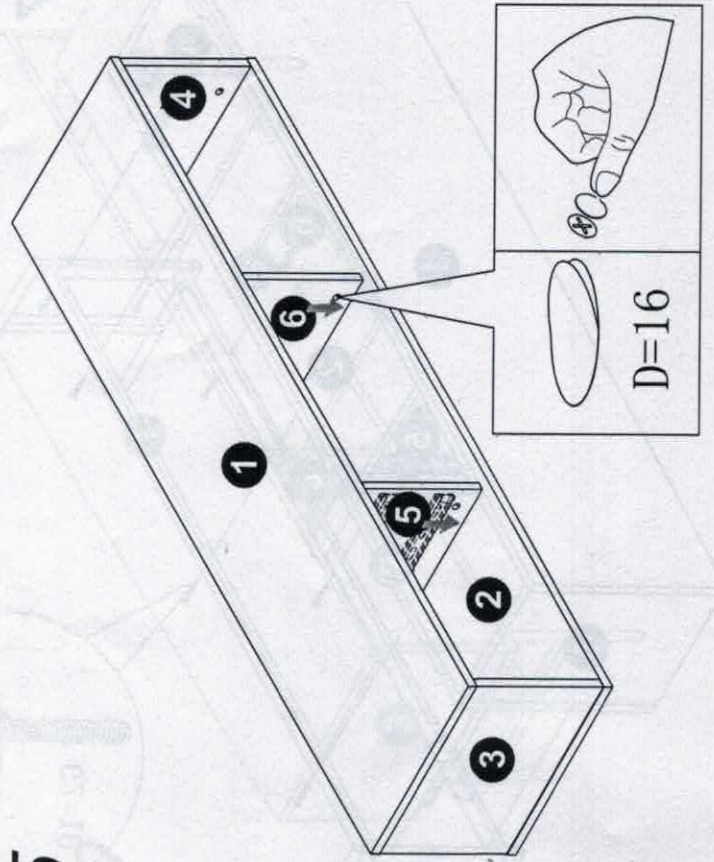
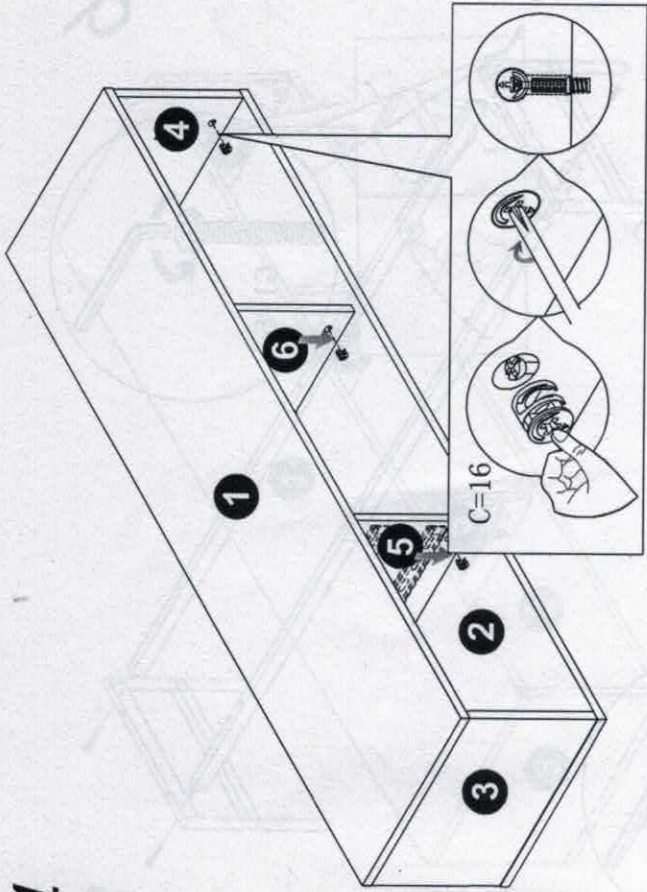

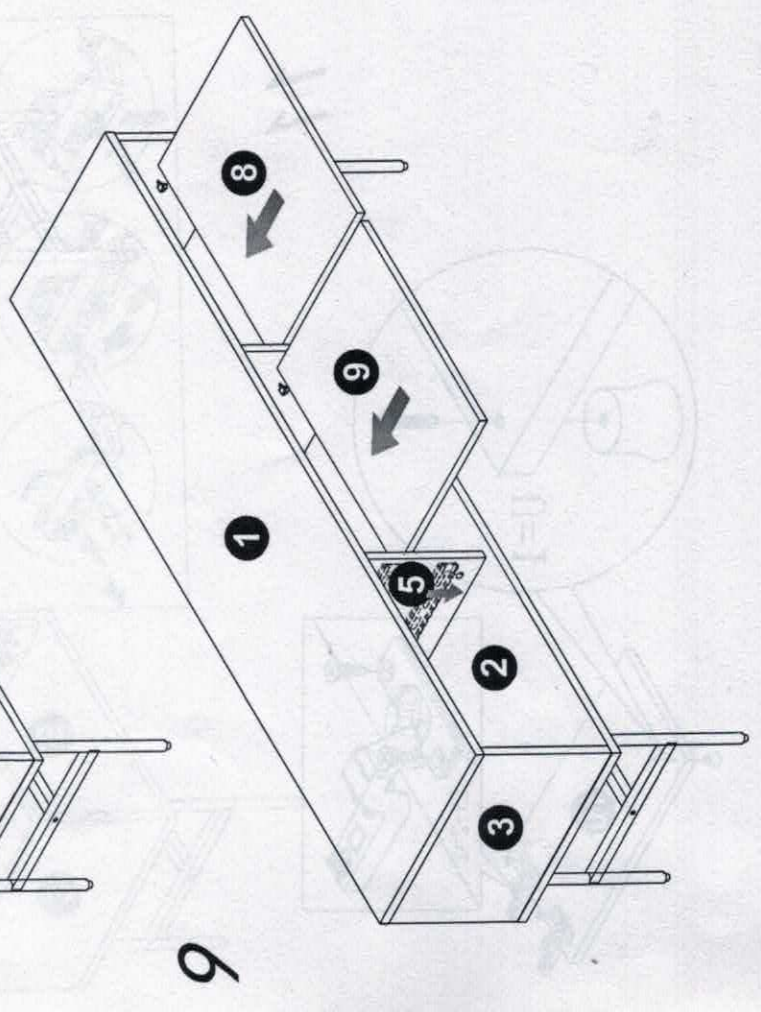
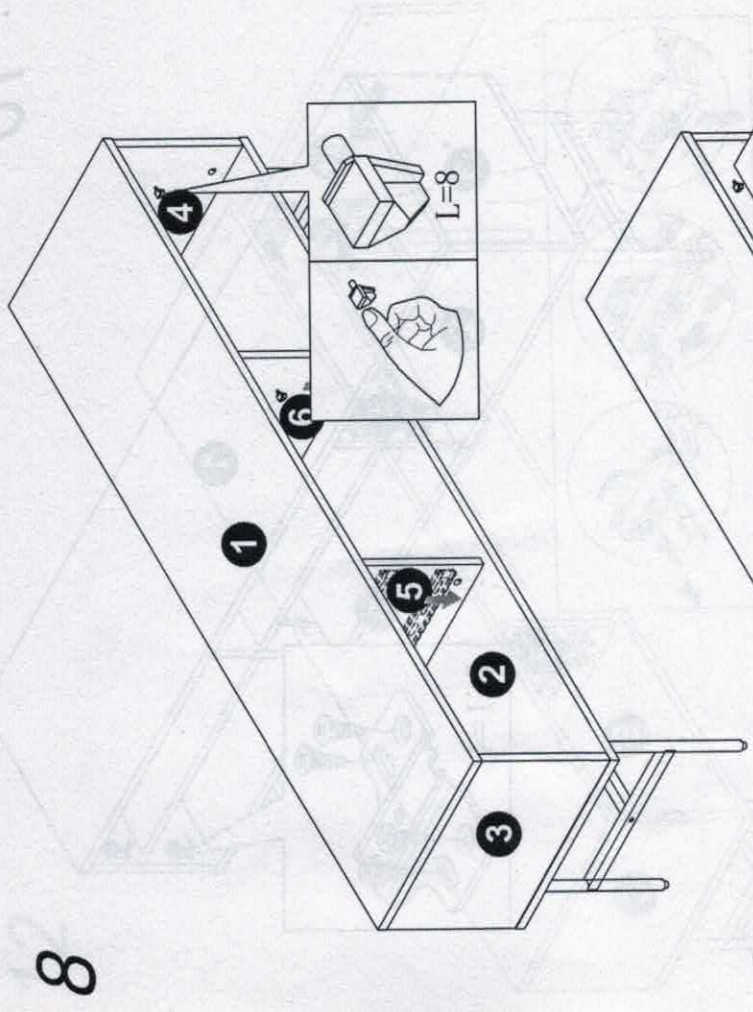
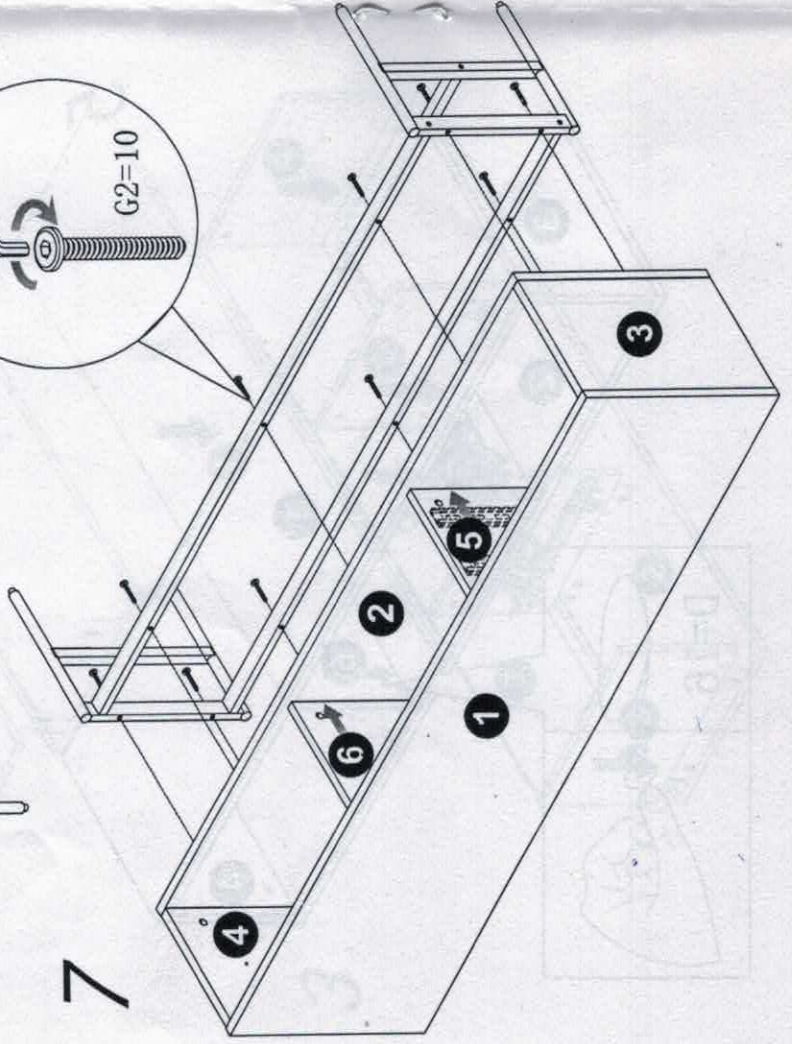
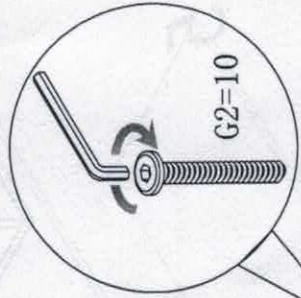
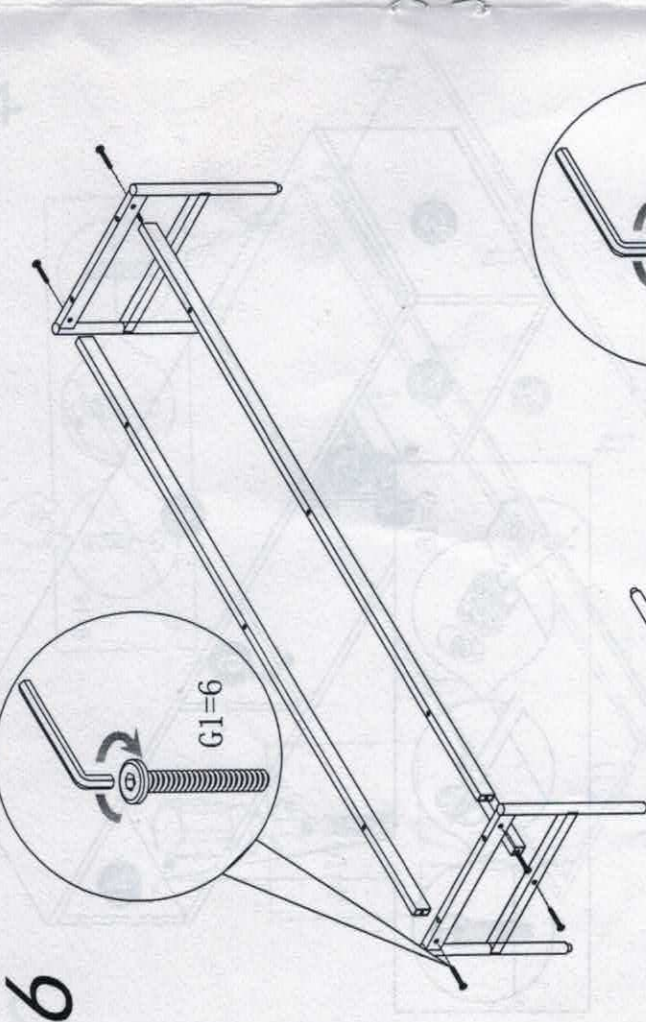

10

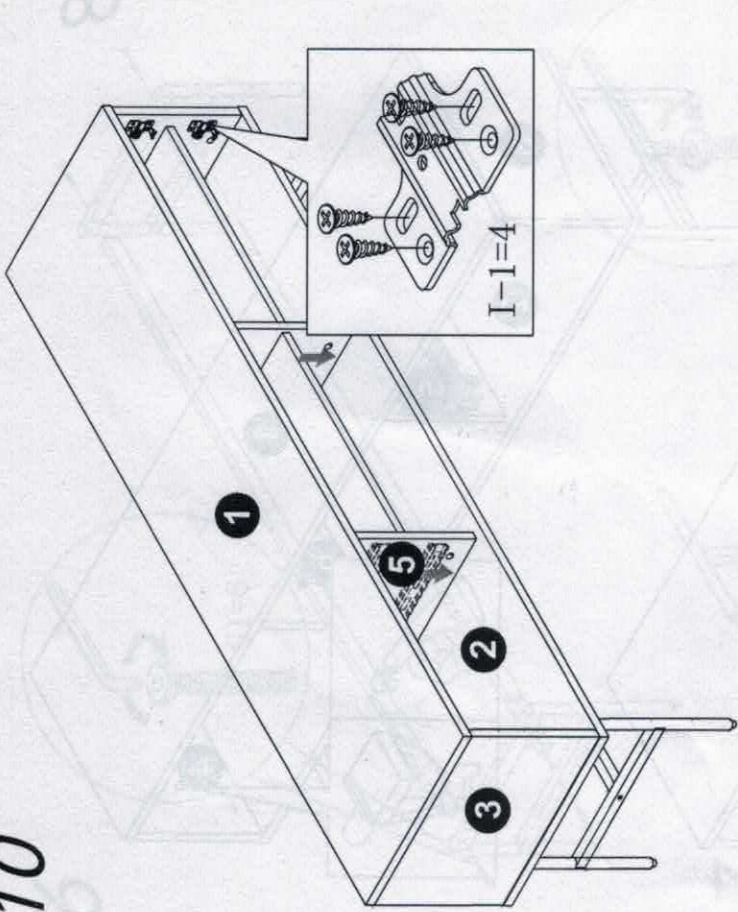

11

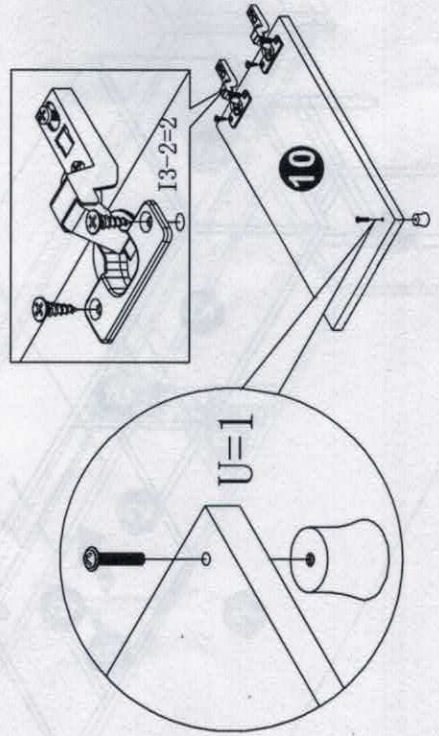

12

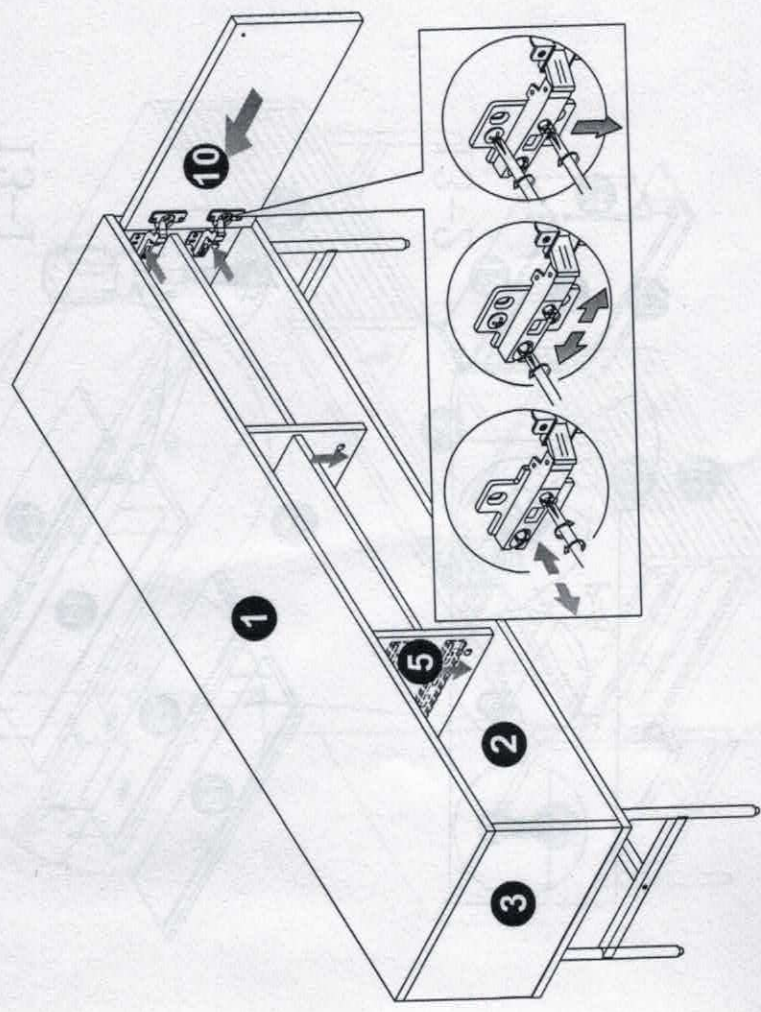

13

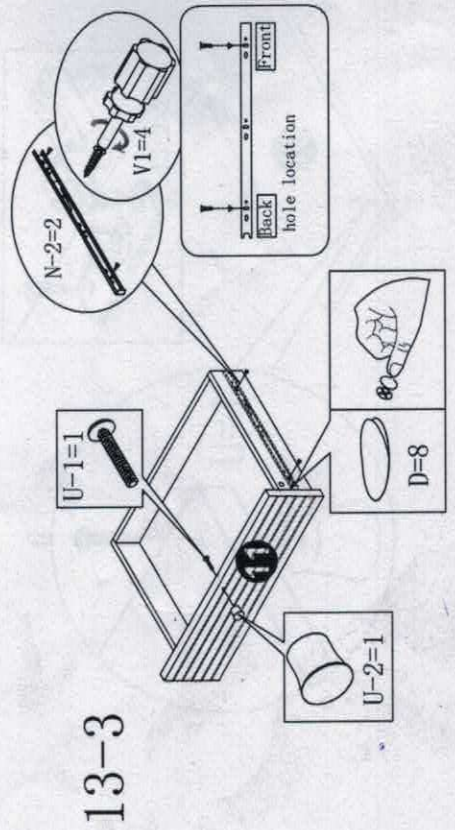
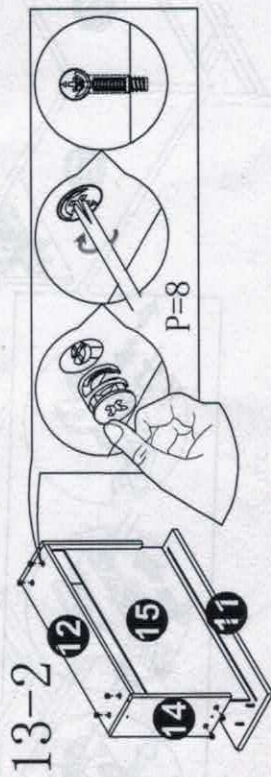
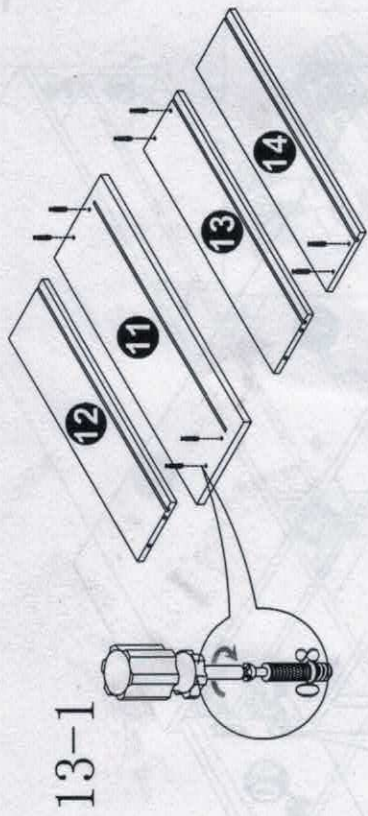

X2

14

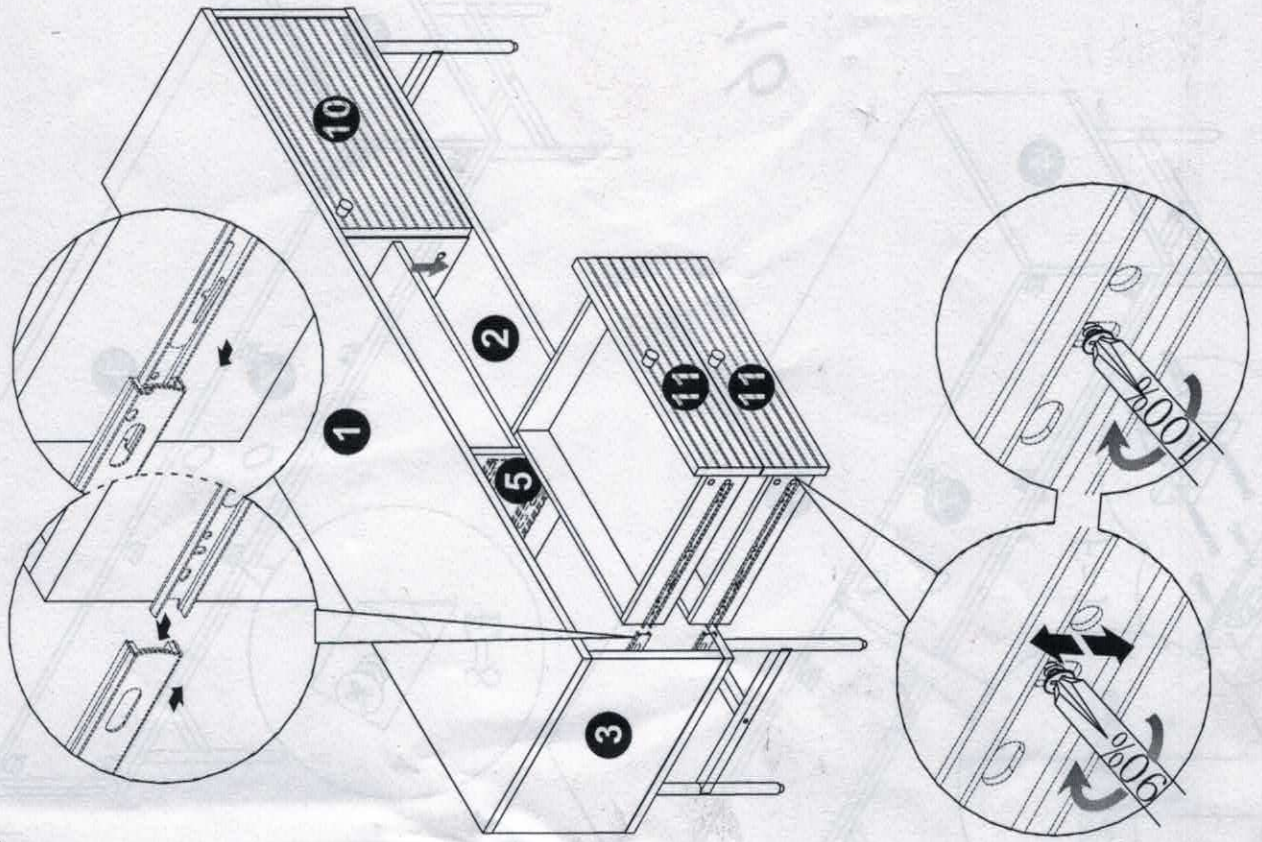

15

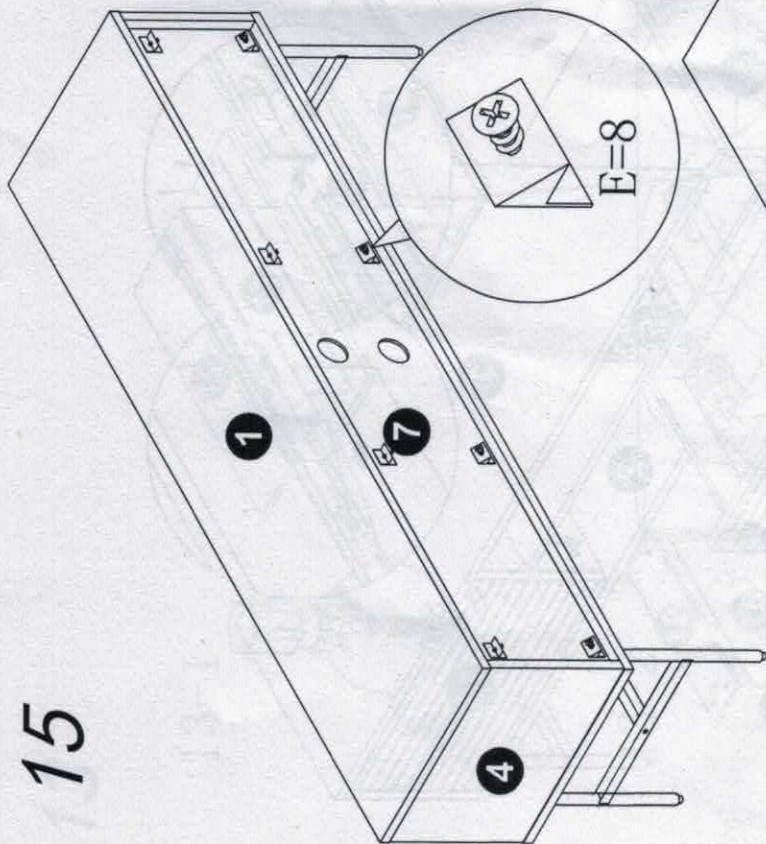

16

